

'TIS THE SEASON

Fairmont
PACIFIC RIM

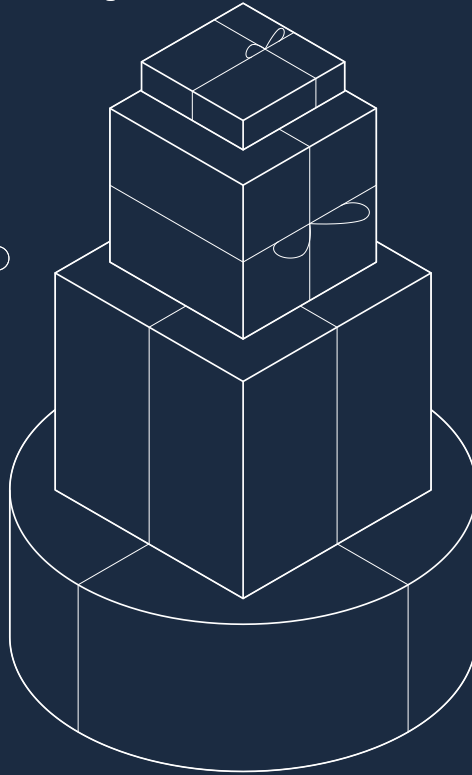

Celebrate the holidays
at Fairmont Pacific Rim

UNWRAP THE HOLIDAYS
AT FAIRMONT PACIFIC RIM



ACCOMMODATION

| | |
|---------------------------|---|
| <u>Winter Wellness</u> | 6 |
| <u>Festive Escape</u> | 7 |
| <u>Christmas in Style</u> | 8 |

SAY HELLO TO SANTA

| | |
|---|----|
| <u>Santa's Modernized Sleigh Patio Pop-Up</u> | 10 |
|---|----|

THE NORDIC SPA

| | |
|--|----|
| <u>Vancouver's Ultimate Wellness Retreat</u> | 11 |
|--|----|

FAIRMONT SPA

| | |
|-----------------------------|----|
| <u>Festive Spa Packages</u> | 12 |
| <u>Pamper Me Program</u> | 14 |
| <u>Gifting</u> | 15 |

DINING

| | |
|---|----|
| <u>Festive Cocktails & Live Music at The Lobby Lounge</u> | 16 |
| <u>Making Spirits Brighter at Botanist Bar</u> | 17 |
| <u>Holiday Brunch at Botanist</u> | 18 |
| <u>Christmas Dinner at Botanist</u> | 18 |
| <u>New Year's Eve at Botanist</u> | 19 |
| <u>New Year's Eve at The Lobby Lounge</u> | 19 |
| <u>Festive In-Room Dining</u> | 20 |
| <u>Dining Gift Cards</u> | 21 |

JOIN US

| | |
|--|----|
| <u>Accor's ALL Lifestyle Loyalty Program</u> | 23 |
|--|----|

SEASON'S GREETINGS

| | |
|--|----|
| <u>What's Happening Around the Hotel</u> | 24 |
|--|----|



IT'S THE MOST
WONDERFUL TIME
OF THE YEAR

Step into the wondrous world of Fairmont Pacific Rim this holiday season, where each moment is infused with festive magic.

Immerse yourself in the joy of the holidays as you explore our thoughtfully curated experiences - from rejuvenating escapes at The Nordic Spa and indulgent treatments at Fairmont Spa, to the season's finest dining and cocktails at Botanist and The Lobby Lounge & RawBar.

Celebrate in style with exclusive seasonal room packages that promise everything from wellness-focused getaways to enchanting festive escapes.

Discover our full array of holiday offerings at fairmontpacificrim.com/holidays.

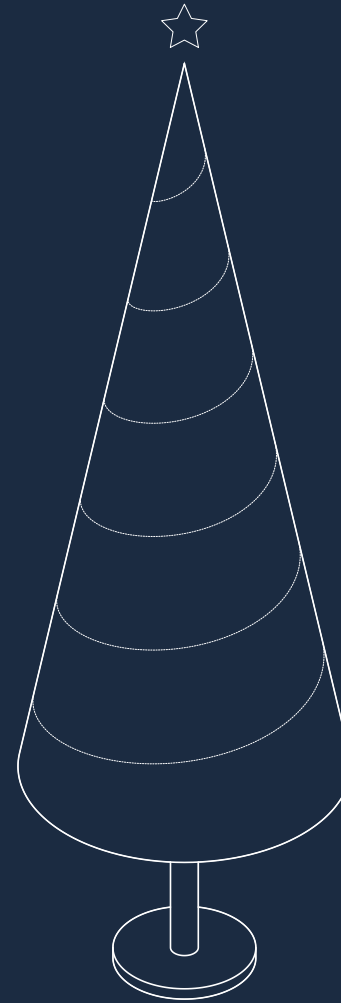

ABOUT FAIRMONT PACIFIC RIM

Fairmont Pacific Rim is a Forbes Five-Star luxury contemporary hotel located in the heart of Vancouver and surrounded by breathtaking mountain and harbour views. Complete with curated rotating in-house exhibitions, a world-class spa, innovative restaurants and award-winning cocktail bars, guests are invited to immerse themselves in a unique experiential escape.

SPEND THE HOLIDAYS UNDER ONE ROOF

WINTER WELLNESS

Escape the winter chill and rejuvenate your mind, body and spirit with a curated blend of wellness experiences. Begin with a Sole Revival treatment for two at Fairmont Spa, where soothing aromatherapy and expert care restore tired feet and promote deep relaxation. Your journey continues with reserved access to The Nordic Spa, where the invigorating contrast of heat and cold therapies helps you unwind in complete tranquility. Paired with delicious amenities, this winter escape offers the perfect balance of restoration and indulgence.

- Overnight stay in a Deluxe Room
- Welcome amenity
- 60-minute Sole Revival treatment at Fairmont Spa for two people
- Access to The Nordic Spa for two people

To book, scan the QR code below or visit fairmontpacificrim.com/offers/winter-wellness-offer.



Rates starting from \$1,422++ CAD. 14 days advance booking is required. This offer is bookable until April 16, 2025 for stays until April 30, 2025.

FESTIVE ESCAPE

Step into a world of seasonal delight, where luxurious accommodations and thoughtful touches come together for an unforgettable stay. Enjoy leisurely mornings with breakfast, relax at The Nordic Spa, our self-guided outdoor thermal spa, and indulge in seasonal cocktails and a family-style meal that captures the warmth of the season. It's the perfect blend of celebration and relaxation.

- Overnight stay in a Deluxe Room
- Festive welcome amenity
- Breakfast at Botanist for two people
- Access to The Nordic Spa for two people
- Festive cocktails and a family-style lunch in The Lobby Lounge (\$200 credit total)

To book, scan the QR code below or visit fairmontpacificrim.com/offers/festive-escape.



Rates starting from \$1,218++ CAD. 72 hours advance booking is required. This offer is bookable until December 28, 2024 for stays until December 31, 2024.

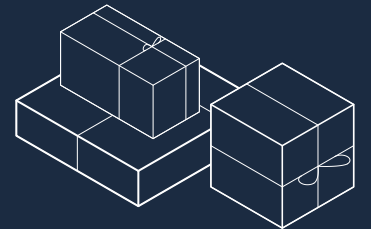

CHRISTMAS IN STYLE

Celebrate the season in ultimate luxury with our Christmas in Style package, designed to help you create unforgettable holiday memories.

Your stay begins on December 24 with a festive welcome amenity, Champagne and a Christmas tree in your suite. Cozy up in personalized bathrobes, explore the Vancouver Christmas Market and enjoy a Fairmont Signature Massage before savouring festive cocktails and dinner at The Lobby Lounge & RawBar.

On December 25, delight in our special holiday brunch and Christmas Day dinner at Botanist, where seasonal flavours and expert wine pairings create the perfect festive feast. The celebrations continue on December 26 with a leisurely breakfast served in-suite and a late checkout, giving you more time to soak in the magic of your holiday escape.

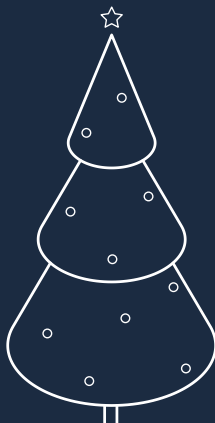
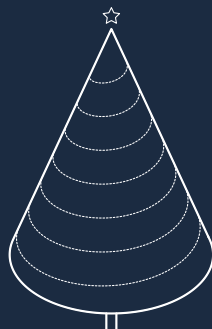
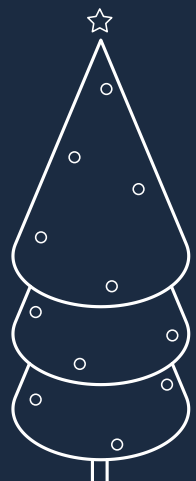

- Two-night stay in a Signature Harbour Mountain View Suite
- Glass of Champagne on arrival
- Festive welcome amenity
- Christmas tree in suite
- Two personalized bathrobes to take home
- Tickets to the Vancouver Christmas Market
- 60-minute Fairmont Signature Massage for two people
- Festive cocktails and a family-style dinner at The Lobby Lounge & RawBar (\$400 credit total)
- Breakfast served in suite
- Christmas Day dinner at Botanist for two people, with wine pairings
- Holiday brunch at Botanist for two people
- Late checkout

To book, scan the QR code below or visit fairmontpacificrim.com/offers/christmas-in-style.



Rates starting from \$5,246++ CAD. Three weeks advance booking is required. This offer is bookable until December 2, 2024. Valid only for stays from December 24-26, 2024.

SAY HELLO TO SANTA

SANTA'S MODERNIZED SLEIGH PATIO POP-UP

Capture the magic of the holidays in Santa's Modernized Sleigh, a travelling winter wonderland making stops all over Vancouver.

On December 19, from 11:00am - 2:00pm, warm up with cookies and cocoa on the Fairmont Pacific Rim Plaza. Snap a photo with Santa and share your holiday list for an unforgettable festive moment with your loved ones.

To learn more, scan the QR code below or visit fairmontpacificrim.com/holidays.



Discover The Nordic Spa at Fairmont Pacific Rim, Vancouver's ultimate wellness retreat. Surrounded by breathtaking harbour and mountain views, our self-guided outdoor thermal spa offers an immersive healing experience that encompasses the essence of the West Coast.

Soak in the hot tub, submerge in cold plunge baths and find solace in our cedar plank sauna where you can stretch and sweat. Be gently reintroduced into reality in heated relaxation areas while draped in cozy robes and slippers, and nourish yourself with a delicious menu of seasonal and local dishes.

The Nordic Spa is located on our sixth floor pool deck. To book, scan the QR code below or visit fairmontpacificrim.com/nordicspa.

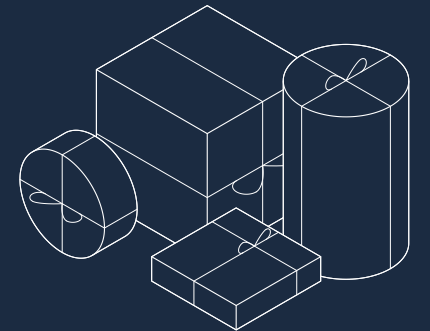

A ONE-WAY TICKET TO THE NORDIC SPA, PLEASE

FESTIVE SPA PACKAGES

Winter Sole-stice

Escape into a winter retreat that will leave you feeling completely renewed. With deeply restorative treatments and moments of indulgence, this experience for two is designed to refresh skin, revive tired feet and melt away stress.

- 60-minute Skin Essentials facial for two
- 60-minute Sole Revival treatment for two
- Glass of sparkling wine each

Holiday Spirit

Experience deep relaxation with our Spirit of the Pacific treatment and a personalized facial, leaving your skin radiant and your spirit renewed. Top it off with a festive holiday cocktail from our winter menu and you'll walk away feeling revitalized, pampered and ready to embrace the joy of the season.

- 90-minute Spirit of the Pacific treatment
- 60-minute facial
- Holiday cocktail from our winter menu

Silent Night Soak

Reconnect with nature and each other through this immersive experience for two. Your journey begins with the grounding elements of cedar, fir and pine, as a Pacific sea salt scrub cleanses and purifies. Sink into deep relaxation with a detoxifying soak in our Japanese-style Ofuro tub, followed by a heated basalt stone massage that melts away tension. Let a glacial clay mask for your face and feet complete the rejuvenation, as you feel fully restored and connected. Complete your experience with a collagen tea and complimentary valet or self-parking, making this the ultimate escape for your body, mind and spirit.

- 120-minute Rainforest Ritual package for two
- Collagen tea for two
- Complimentary valet or self-parking
- Festive wellness gift

To book, scan the QR code below or visit fairmontpacificrim.com/holidays.



Offers must be mentioned at time of booking. Cannot be combined with any other promotion. Upgrade fees apply for any service substitutes. Non-alcoholic options are available in lieu of cocktails.



PAMPER ME PROGRAM

This holiday season, give the gift of relaxation with Fairmont Spa's Pamper Me Program. Choose between six or 12 months of spa treatments, exclusive offers, access passes and more.

Purchase before December 24, 2024 and receive two complimentary passes to The Nordic Spa (redeemable between January and April, 2025) with two glasses of bubbles.

To learn more, email VPR.SpaReservations@fairmont.com or visit fairmontpacificrim.com/holidays by scanning the QR code below.



FOR THE SPA LA LA LA LOVERS

Treat the spa enthusiast on your list to the ultimate indulgence with a Fairmont Spa gift card. Explore our curated boutique, featuring holiday assortments from Crowfoot Collective, Aromatherapy Associates, Davines, Kerstin Florian and Londre, along with luxurious stocking stuffers.

To purchase a gift card, scan the QR code below or visit buyatab.com/custom/fairmont.

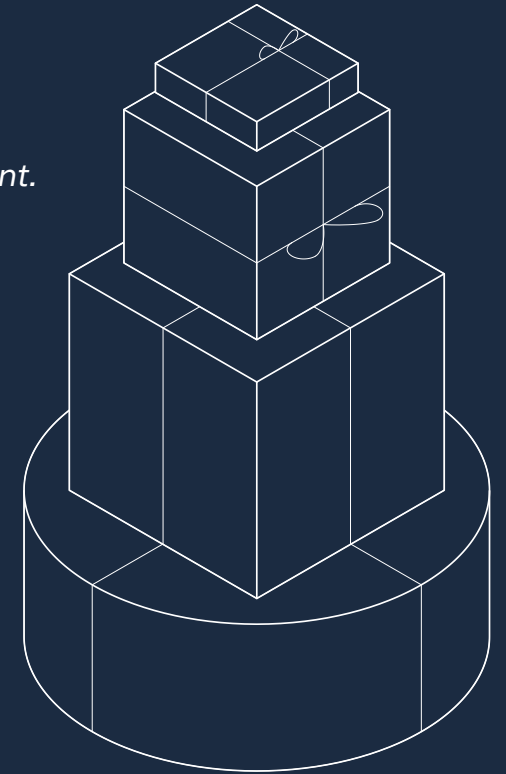

A CUP (OR TWO) OF GOOD CHEER

FESTIVE TIPPLES & TUNES IN THE LOBBY LOUNGE

Get into the holiday spirit with The Lobby Lounge's selection of seasonal cocktails, accompanied by live music each night.

Sip on festive favourites like Hot Buttered Rum, Mulled Cider, Spiked Eggnog and our Sugarplum Fairy cocktail as you cozy up by the fire or enjoy the sounds from the stage.

To view the menu, scan the QR code below or visit lobbysloungebar.com/menu.



MAKING SPIRITS BRIGHTER AT BOTANIST BAR

This holiday season, our expert tastemakers at Botanist Bar are bringing the holiday spirit to life with a curated selection of festive cocktails.

Delight in creations like the Banarama Backflip - a rich blend of bourbon, brandy, banana, maple and cinnamon - or the Gingerbread Old Fashioned, featuring tequila, gingerbread, orange and bitters. For a more traditional festive tipple, try our Remedy Toddy or West Coast Mulled Wine infused with warming Christmas spices.

Whether you're seeking a bold new flavour or a twist on a holiday classic, go ahead and indulge in a cocktail (or two) - we won't tell Santa.

To view the menu, scan the QR code below or visit botanistrestaurant.com/menu.



HOLIDAY BRUNCH AT BOTANIST

December 23, 2024 - January 1, 2025 | 11:30am - 1:30pm | \$89++ per person

Celebrate the season with a festive three-course brunch at Botanist. Begin your experience with a welcome glass of sparkling wine and a holiday-inspired cocktail as live music sets the mood. Savour an array of seasonal dishes, from Slow-Roasted Turkey and Prime Beef Rib Eye to Sablefish Cassoulet, Wild Mushroom Risotto and Lobster Eggs Benedict.

To reserve your table, scan the QR code or visit botanistrestaurant.com/reservations.



Holiday Brunch

CHRISTMAS DINNER AT BOTANIST

December 24 & 25, 2024 | 5:30pm - 9:30pm | \$194++ per person | \$179++ for premium wine or Champagne pairings

Celebrate the magic of Christmas at Botanist with our six-course “We’ll Take It From Here” tasting menu crafted by Executive Chef Hector Laguna. Indulge in seasonal dishes like Crispy Red Snapper, Grilled Octopus and Northern Divine Caviar. End the evening on a sweet note with Executive Pastry Chef Kate Siegel’s decadent Chestnut Cake. A festive evening of culinary delights awaits.

To reserve your table, scan the QR code or visit botanistrestaurant.com/reservations.



Christmas Eve



Christmas Day

NEW YEAR’S EVE AT BOTANIST

December 31, 2024 | 5:30pm - 10:00pm | \$194++ per person | \$179++ for premium wine or Champagne pairings

As you prepare to bid farewell to 2024, indulge in our six-course “We’ll Take It From Here” tasting menu at Botanist, thoughtfully curated by Executive Chef Hector Laguna. Each dish is a masterpiece, designed to tantalize your taste buds and elevate your senses, setting the perfect stage for a night of elegance and joy.

To reserve your table, scan the QR code or visit botanistrestaurant.com/reservations.



New Year’s Eve

NEW YEAR’S EVE AT THE LOBBY LOUNGE

December 31, 2024 | From 9:30pm

Prepare for a night to remember at The Lobby Lounge this New Year’s Eve. Ring in 2025 with captivating live music by the Stephen Lecky and Desmond Dae Duo, and late night with DJ Kyrios.

To reserve your table, scan the QR code or visit fairmontpacificrim.com/holidays.



New Year’s Eve

FESTIVE IN-ROOM DINING

December 24 & 25, 2024 | 5:30pm - 9:30pm | \$85++ per person
December 31, 2024 | 5:30pm - 9:30pm | \$95++ per person

Available Christmas Eve, Christmas Day and New Year's Eve, enjoy a three-course holiday feast from the comfort of your suite. Delight in classic dishes like Roasted Fraser Valley Turkey, served with all the festive fixings, or our Miso-Glazed Sablefish, featuring a crispy rice crust, nori powder and a colourful medley of braised sui choi, edamame, daikon and white dashi shoyu.

Top off your dinner with a delicious Eggnog Bavaroise. To further elevate your meal, add our Sommelier-selected wine pairings.

To book, scan the QR code below or visit fairmontpacificrim.com/holidays.



Please note that this experience is only available in select room types and suites.

GIVE THE GIFT OF EXQUISITE DINING

This Christmas, delight the foodies in your life with a passport to culinary adventure.

Our gift cards for Botanist and The Lobby Lounge & RawBar allow recipients to indulge in exquisite dishes crafted by our talented chefs or sip on expertly mixed cocktails in beautiful surroundings.

For more information, scan the QR code below or visit fairmontpacificrim.com/holidays.

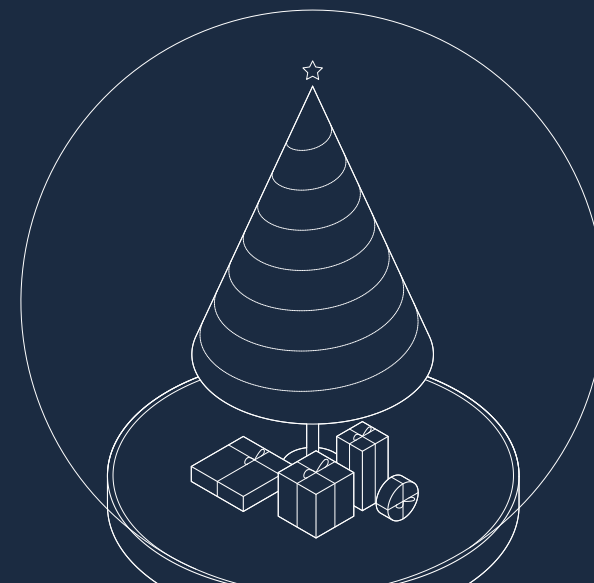

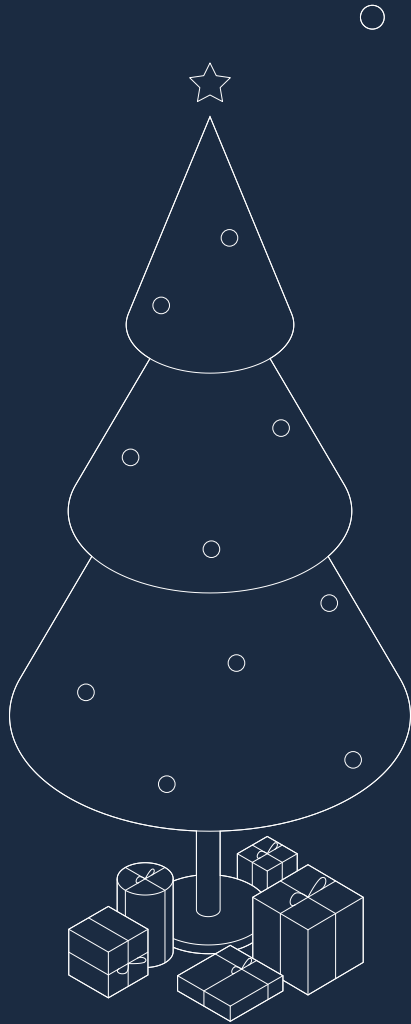

JOIN THE ALL LIFESTYLE LOYALTY PROGRAM

Unlock a world of rewards and exclusive perks at Fairmont Pacific Rim by becoming a member of Accor's ALL Lifestyle Loyalty Program.

Whether it's dining at our Michelin Recommended Botanist restaurant, sipping award-winning cocktails at The Lobby Lounge or indulging in a serene escape at our Forbes Five-Star Fairmont Spa, your ALL membership opens the door to it all.

Enjoy savings of up to 10% on bookings at over 3,000 hotels, starting with your very first reservation.

To enroll, scan the QR code below.





Feeling festive? Here are some shops, stops and sips not to be missed around the hotel.

THE PACIFIC GALLERY

This festive season, immerse yourself in the captivating world of *Sight Lines*, the latest exhibition at The Pacific Gallery at Fairmont Pacific Rim. Featuring the innovative works of photographer Marten Elder and artists Erin McSavaney and Renée Van Halm, this collection invites you to see architecture in a new light.



Running until January 2025, the exhibition challenges perceptions of the built environment through stunning photography and vibrant paintings that transform ordinary structures into extraordinary art.

Located on the second floor of the hotel, *Sight Lines* offers a unique and thought-provoking experience for both art enthusiasts and casual observers alike.



TASCHEN LIBRARY

Located on the second floor of the hotel, the TASCHEN Library presents a diverse portfolio of more than 275 books that celebrate innovation and cultural creativity, ranging from artist monologues to signed Collectors Editions.

Open daily, 10:00am-9:00pm.

HOUSE iD

HOUSE iD creates performance apparel and loungewear for those who are always in motion. Designed in Vancouver, made in Los Angeles - their sweat collection is engineered to make you feel at home, wherever you are.

Open Monday to Friday, 12:00pm-6:00pm, and Saturday and Sunday, 10:00am-4:00pm.

LEAH ALEXANDRA JEWELRY

The Leah Alexandra Jewelry pop-up boutique is located in our hotel lobby. Designed and made in her Vancouver studio, Leah Alexandra's jewelry is meant to be loved and treasured for years to come.

Open Sunday to Wednesday, 10:00am-6:00pm, and Thursday to Saturday, 11:00am-7:00pm

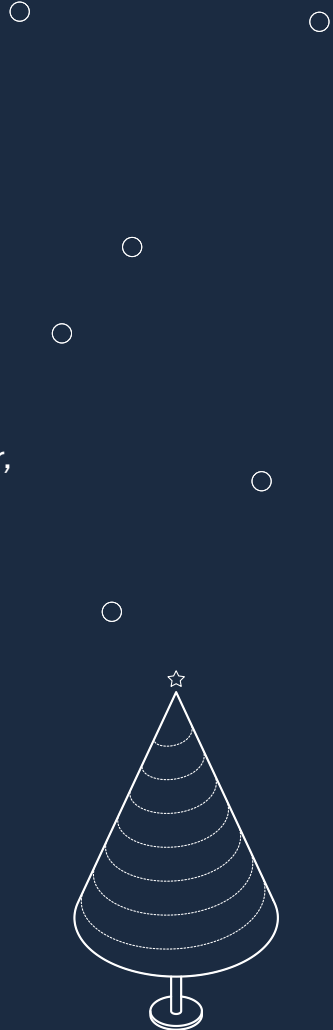

GIOVANE CAFFÈ & BACARO

Inspired by the modern Italian caffè, Giovane offers espresso-based beverages, pastries, sandwiches and salads. Next door, Bacaro is a modern Italian restaurant that takes influence from the traditional Venetian bacaro.

Giovane Caffè: Open daily from 7:00am-6:00pm.

Bacaro: Open daily from 11:00am-10:00pm.

IVY ROOM

Located in our lobby, Ivy Room is a boutique floral studio dedicated to creating exquisite designs that blend timeless elegance with contemporary flair for both special events and everyday occasions.

Open daily from 11:00am-7:00pm.

To learn more about our partners, scan the QR code below or visit fairmontpacificrim.com/holidays.





Fairmont
PACIFIC RIM

pacificrim@fairmont.com | [@fairmontpacific](https://www.instagram.com/fairmontpacific)

1038 Canada Place
Vancouver, BC, V6C 0B9

[fairmontpacificrim.com/holidays](https://www.fairmontpacificrim.com/holidays)